



*Garage Doors With  
A Unique Quality*

GARAGE DOOR PRICE LIST  
JULY 2009



*Wessex Doors is Europe's largest manufacturer of low maintenance G.R.P. (Glass Reinforced Polyester) garage doors and a leading innovator in the field of garage door design.*

*Based in Verwood, Dorset, Wessex Doors manufacture a range of hand built and finished doors in strong durable G.R.P. with either luxury Gloss White or faithfully reproduced Woodgrain finishes.*

## *Garage Doors with a Unique Quality*

### Welcome to the Wessex Garage Doors Price List

G.R.P is an incredibly strong, dent resistant modern composite laminate with a better strength to weight ratio than steel. The door face is devoid of joints, seams, rivets or fastenings to detract from its good looks. All doors are supplied fully finished, won't warp, shrink or rust and are virtually maintenance free.

### *Impact tested*

We've all done it - misjudged our parking and nudged the garage door or had budding David Beckhams use the garage door as a target for that curving free kick...

With most garage doors the result is a permanent reminder - an unsightly dent. With a G.R.P garage door the effect is more likely to be no effect at all!

Wessex G.R.P. doors have been tested in-house using similar methods to the European standard impact test for double glazed units. The tests easily demonstrated the unique resilience of a GRP garage doors to every day knocks and bumps - Ask your distributor to see the film of the tests for yourself!

Such strength does not come at the expense of style - the high gloss white and Woodgrain finishes are matchless for their good looks.

The Wessex Gloss White Range combines crisp, clean panel definition with traditional and exclusive styling designed to complement any home. The Wessex Woodgrain Range offers the benefit of a beautiful timber grained door without the time consuming upkeep timber doors usually require.

### *A style for every home*

Combine the choice of build qualities with a selection of Gloss White or Woodgrain woodtones, a wealth of window options and you will discover that matching the right Wessex G.R.P. door to your home has never been easier.

This price list covers the complete range of doors available from Wessex. For full details of the ranges please visit [www.wessexdoors.co.uk](http://www.wessexdoors.co.uk).

## *Contents:*

G.R.P. SECTIONAL GARAGE DOORS	4
G.R.P. UP AND OVER GARAGE DOORS	6 - 11
G.R.P. SIDE HINGED GARAGE DOORS	12 - 13
STEEL UP & OVER GARAGE DOORS	14
TIMBER UP & OVER GARAGE DOORS	15
UP & OVER DOOR OPTIONS	16
AUTOMATION	17
UP & OVER OPERATING GEAR TECHNICAL DETAILS	18 - 19
WARRANTY	20

## TECHNICAL & GENERAL INFORMATION

### VIENNA

Vienna is a double skinned fully finished and made to measure G.R.P. Sectional Garage door. The panels are made from triple layer resin 450 gram CSM glass mat reinforcement and 'matted in' steel stiffeners. The rear of the door is finished with a white flat back panel. Doors over 4420mm (14'6") have additional white powder coat bracings attached to the rear of the panels. Vienna features full weather seals on both sides, at the head and where the door closes to the ground to reduce water and wind borne debris ingress. The interface of each panel has an anti finger-trap CEN compliant safety design (patent pending). Vienna is available in High Gloss White and all standard Wessex Woodgrain colours including the three solid colour options.

### VIENNA DC

Vienna DC has all the benefits of Vienna but is supplied with a state-of-the-art electric operator which is matched to the Vienna door. A DC650NIII, with a 650N lifting force, is supplied for doors up to 3048mm (10'0") wide and the more powerful DC800NIII, with 800N lifting force, is supplied for doors over this size. Both operators feature DC motors, soft start-soft stop and anti-back drive security system. This reacts to movement on the boom, if forced entry of a closed door is attempted, and automatically switches from stand-by mode to drive the door closed. A very quiet toothed cable drive one-piece boom is standard with chain drive available as a no cost option. A kevlar belt drive option is available for even smoother, quieter operation. Please note that an extended boom is recommended for doors over 2134mm (7'0") high.

### VIENNA 40

Vienna 40 has double skinned, foam filled, insulated panels for maximum insulation, sound proofing and strength. The rear of the door is finished with a white flat back panel. Doors over 4420mm (14'6") have additional white powder coat bracings attached to the rear of the panels. Vienna 40 also has all round weather seals and an anti finger-trap panel interface design (patent pending). Vienna 40 is available in High Gloss White and all standard Wessex Woodgrain colours including the three solid colour options.

### VIENNA 40 DC

Vienna 40 DC has all the benefits of Vienna 40 but is supplied with a state-of-the-art electric operator which is matched to the Vienna 40 door. A DC650NIII, with a 650N lifting force, is supplied for doors up to 3048mm (10'0") wide and the more powerful DC800NIII, with 800N lifting force, is supplied for doors over this size. Both operators feature DC motors, soft start-soft stop and anti-back drive security system. This reacts to movement on the boom, if forced entry of a closed door is attempted, and automatically switches from stand-by mode to drive the door closed. A very quiet toothed cable drive one-piece boom is standard with chain drive available as a no cost option. A Kevlar belt drive option is available for even smoother, quieter operation. Please note that an extended boom is recommended for doors over 2134mm (7'0") high.

### GEARING

Vienna lifting gear is a CEN Compliant galvanised steel dual track system with standard low head room gear. Vienna requires only 70mm side and headroom clearance and the top edge of the top panel does not rise above the horizontal track. If the 'Manual locking' option is selected, headroom requirement increases by 60mm and both DC variants require an additional 30mm headroom for the operator boom (50mm on doors over 4420mm / 14'6"). The spring assembly is not wider than the track which means easy installation to flush walls. There is no reduction of drive through width and drive through height is reduced by only 70mm on a manual door and 30mm on an automated door.

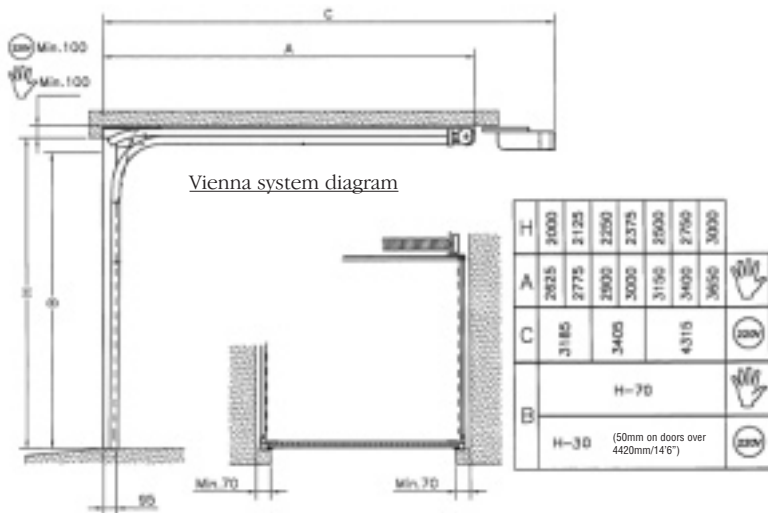

## GENERAL INFORMATION

### Locking

**All Vienna variants are supplied without locking.** If ordered as a manually operated door, or locking is required, the 'Manual locking' option must be ordered. The door is prepared for the handle to fit in the first right hand vertical stile, viewed from outside, on the second panel up from the floor.

### Window Options

Vienna, Vienna 40 and DC variants are available with black (opaque) windows, which cannot be seen through. Clear and stippled translucent windows are not available.

### Matching Woodgrain Vienna Doors

Where doors are to be fitted in close proximity and are required to be coloured as closely as possible, it is vital that they are clearly requested 'To Match' at time of ordering.

### Made to Measure Vienna Doors

For a made to measure price take the next door size up e.g. 3810mm (12'6") wide x 2032mm (6'8") high is taken from the 3962mm (13'0") wide x 2134mm (7'0") high price.

### Opening Size

All door sizes in this price list refer to internal brickwork / internal frame dimensions. See note "How to order your Door"

### How to Order Your Door

Sectional doors are designed to be fitted either on to the back face of a brickwork opening or on to the back face of a timber frame\* fitted within the opening. Therefore when ordering your door you must either give us the internal brickwork opening size for doors being fitted directly to the back of the brickwork, or the internal timber frame\* size for doors being fitted on to a timber frame\*.

\*Timber frame must be a minimum of 70mm x 70mm (2 7/4" x 2 7/4").

### Top & Bottom Rails & End Stiles

Top, bottom and end stiles (edges) may vary in width or height between doors of the same style depending on size ordered. This is to enable us to cater for your particular size of garage door. If in doubt, please refer to Wessex before ordering.

## FINISHING & MAINTENANCE





### G.R.P. Doors

Please study the cleaning and maintenance label attached to the back of the door for advice on keeping your door in top class condition.

### Door Lubrication

All doors require regular (6 monthly) lubrication of the pivot points and bearings. Full details are contained in the Wessex Service Passport supplied with the door.

## KEY TO SYMBOLS

-  S-S Standard Sizes only
-  M-M Made to Measure available
-  Glazing option available
-  7+ Doors available over 2134mm (7'0") high

## IMPERIAL - METRIC CONVERSION TABLE

Imperial	6'6"	7'0"	7'5"	7'6"	8'0"	9'0"	10'0"
Metric (mm)	1981	2134	2261	2286	2438	2743	3048





Imperial	11'0"	12'0"	13'0"	14'0"	15'0"	16'0"	17'0"
Metric (mm)	3353	3658	3962	4267	4572	4877	5182





## DELIVERY CHARGES

### ALL DOORS

Delivery charges any quantity of door: £45.00 NET

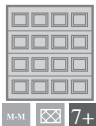
Mainland England, Scotland and Wales only. Northern Ireland, Channel Islands, Isle of Man, and export delivery - charges on application. Carriage charges and VAT to be added to all prices.

G.R.P. GLOSS WHITE									
	VIENNA		VIENNA DC		VIENNA 40		VIENNA 40 DC		
WIDTH	Height 6'6" to 7'0" 1981 to 2134(mm)	Height >7'0" to 7'6" 2134 to 2286(mm)	Height 6'6" to 7'0" 1981 to 2134(mm)	Height >7'0" to 7'6" 2134 to 2286(mm)	Height 6'6" to 7'0" 1981 to 2134(mm)	Height >7'0" to 7'6" 2134 to 2286(mm)	Height 6'6" to 7'0" 1981 to 2134(mm)	Height >7'0" to 7'6" 2134 to 2286(mm)	
2134mm (7'0")	1541	1670	1847	1977	1894	2023	2200	2329	
2438mm (8'0")	1579	1710	1885	2016	1940	2071	2246	2378	
2743mm (9'0")	1629	1754	1936	2061	1972	2098	2279	2405	
3048mm (10'0")	1879	2004	2186	2310	2568	2693	2874	2999	
3353mm (11'0")	2004	2130	2382	2508	2693	2819	3071	3197	
3658mm (12'0")	2130	2255	2508	2633	2819	2944	3197	3322	
3962mm (13'0")	2255	2380	2633	2758	2944	3070	3322	3448	
4267mm (14'0")	2110	2233	2488	2611	2792	2915	3170	3293	
4572mm (15'0")	2505	2630	2883	3008	3194	3320	3572	3698	
4877mm (16'0")	2630	2755	3008	3133	3320	3443	3698	3821	
<b>MtoM widths: 6'10" to 16'0"</b> <b>MtoM heights: 6'6" to 7'6"</b>					<b>MtoM widths: 6'10" to 16'0"</b> <b>MtoM heights: 6'6" to 7'6"</b>				
<b>MtoM widths (mm): 2083 to 4877</b> <b>MtoM heights (mm): 1981 to 2286</b>					<b>MtoM widths (mm): 2083 to 4877</b> <b>MtoM heights (mm): 1981 to 2286</b>				

G.R.P. WOODGRAIN									
	VIENNA		VIENNA DC		VIENNA 40		VIENNA 40 DC		
WIDTH	Height 6'6" to 7'0" 1981 to 2134(mm)	Height >7'0" to 7'6" 2134 to 2286(mm)	Height 6'6" to 7'0" 1981 to 2134(mm)	Height >7'0" to 7'6" 2134 to 2286(mm)	Height 6'6" to 7'0" 1981 to 2134(mm)	Height >7'0" to 7'6" 2134 to 2286(mm)	Height 6'6" to 7'0" 1981 to 2134(mm)	Height >7'0" to 7'6" 2134 to 2286(mm)	
2134mm (7'0")	1670	1798	1977	2105	2023	2150	2329	2456	
2438mm (8'0")	1710	1842	2016	2149	2071	2203	2378	2510	
2743mm (9'0")	1754	1879	2061	2186	2098	2222	2405	2529	
3048mm (10'0")	2004	2130	2310	2436	2693	2819	2999	3125	
3353mm (11'0")	2130	2255	2508	2633	2819	2944	3197	3322	
3658mm (12'0")	2255	2380	2633	2758	2944	3070	3322	3448	
3962mm (13'0")	2380	2505	2758	2883	3070	3194	3448	3572	
4267mm (14'0")	2240	2363	2618	2741	2923	3045	3301	3423	
4572mm (15'0")	2630	2755	3008	3133	3320	3443	3698	3821	
4877mm (16'0")	2755	2881	3133	3259	3443	3569	3821	3947	
<b>MtoM widths: 6'10" to 16'0"</b> <b>MtoM heights: 6'6" to 7'6"</b>					<b>MtoM widths: 6'10" to 16'0"</b> <b>MtoM heights: 6'6" to 7'6"</b>				
<b>MtoM widths (mm): 2083 to 4877</b> <b>MtoM heights (mm): 1981 to 2286</b>					<b>MtoM widths (mm): 2083 to 4877</b> <b>MtoM heights (mm): 1981 to 2286</b>				

## VIENNA OPTIONS

Manual locking	44
Black windows on single doors up to 2438mm (8'0") wide (please specify leading requirements)	125
Black windows on double doors over 2438mm (8'0") wide (please specify leading requirements)	250
Colour Option available for Woodgrain doors only - blue, green and red - for single doors up to 2438mm (8'0") wide	250
Colour Option available for Woodgrain doors only - blue, green and red - for double doors over 2438mm (8'0") wide	370

## VIENNA DC OPTIONS

Beam break	70
Chain Drive	0
Kevlar Belt drive	48
DC800NII upgrade (for Vienna & Vienna 40 up to 3048mm (10'))	68
Emergency exterior release kit	31
Exterior keyless digital entry pad	93
External receiver	102
Mini transmitter (4 channel)	49
Three function wall control	37
Two piece extended toothed belt / chain drive boom	21
Two piece extended Kevlar belt drive boom	74



## TECHNICAL & GENERAL INFORMATION

### G.R.P. CROWN RANGE

**• 3 Crown G.R.P. Doors**

Garage doors in standard and made to measure sizes, with an integral steel frame bonded over to provide added strength and rigidity. Available with canopy or retractable gear.

**• 4 Crown G.R.P. Doors**

Garage doors in standard and made to measure sizes, Featuring a double skin flat back construction with internal steel reinforcing. Doors over 10' wide feature external white powder coated steel horizontal stiffeners to the rear of the panel for increased rigidity. Available with canopy or retractable gear.

**• 5 Crown G.R.P. Doors**

Garage doors in standard and made to measure sizes, with an integral steel frame with a flat back G.R.P. panel bonded to the back of the door. This provides supreme rigidity and an attractive backing to hide the bracing normally visible on all other G.R.P. doors. Available with retractable gear only. Due to the double-wall construction of these doors, no clear or stippled window options are available. NB. 5 Crown doors are only available up to a maximum of 3048mm (10'0") wide and a maximum of 2134mm (7'0") high.

### GEARING

**• SafeLift (Canopy) Gear**

Canopy doors between 1778mm(5'10") and 2134mm (7'0") high and up to 2438mm (8'0") wide are fitted with SafeLift gear featuring high security three point locking and five point retention.

**• Maxi-mizer Single Retractable Gear**

All retractable doors (excluding 5 Crown) between 1829mm (6'0") and 2286mm (7'6") high and up to 2438mm (8'0") wide and all 5 Crown doors up to 2286mm (7'6") wide and 2134mm (7'0") high are supplied with Maximizer gear. This gear includes unique maximum opening width feature and multi springing. Three point locking is standard on most doors.



**• Double and Heavy Retractable Gear**

All doors over 2286mm (7'6") high, all 5 Crown doors over 2286mm (7'6") wide and all other doors over 2438mm (8'0") wide are supplied with these gears. All have multi-springing feature.

### LOCKING

All Wessex doors are supplied with secure multi-point locking as standard. Optional brass effect lock available .

### KEY TO SYMBOLS

-  Standard Sizes only
-  Made to Measure available
-  Security Multi-Point Locking

### GENERAL INFORMATION

**• Handle Positions**

These will vary between canopy and retractable doors of the same size and same style, and between doors of different sizes of the same style with the same gear.

**• Handle Holes**

These will be drilled as standard. If a handle hole is not required this must be clearly stated at time of ordering.

**• Glazed G.R.P. Doors**

All window design doors are fitted with standard black (opaque) windows, which cannot be seen through. Clear and stippled translucent windows are available as options on 3 Crown doors only.

**• Matching Woodgrain G.R.P. Doors**

Where doors are to be fitted in close proximity and are required to be coloured as closely as possible, it is vital that they are clearly requested 'To Match' at time of ordering.

**• Made to Measure Door Prices**

Take the next door size up e.g. 3810mm (12'6") wide x 2032mm (6'8") high take the 3962mm (13'0") price. **Note:** Where a price is marked \* please refer to the size parameter details below the price for the actual maximum / minimum door size available.

**• Opening Size**

All door sizes stated in this price list refer to internal frame dimensions. Due to the bespoke nature of Wessex garage doors we regret we can not accept order cancellations.

**• Top & Bottom Rails & End Stiles**

Top, bottom and end stiles (edges) may vary in width or height between doors of the same style depending on size ordered. This is to enable us to cater for your particular size of garage door. If in doubt, please refer to Wessex before ordering.

### FINISHING & MAINTENANCE

**• G.R.P. Doors**

Please study the cleaning and maintenance label attached to the back of the door for advice on keeping your door in top class condition.

**• Steel Frames**

Primed steel frames require a suitable undercoat and topcoat to be applied shortly after delivery in order that the product warranty is not invalidated.

**• Door Lubrication**

All doors require regular (6 monthly) lubrication of the pivot points and bearings. Full details are contained in the Wessex Service Passport supplied with the door.

### IMPERIAL - METRIC CONVERSION TABLE

Imperial	6'6"	7'0"	7'5"	7'6"	8'0"	9'0"	10'0"	11'0"	12'0"	13'0"	14'0"	15'0"	16'0"
Metric (mm)	1981	2134	2261	2286	2438	2743	3048	3353	3658	3962	4267	4572	4877



Luxury 5 Crown G.R.P. Doors available



Glazing Options available – see page 12 for pricing



Frames available – see page 12 for pricing



Doors available over 2134mm (7'0") high











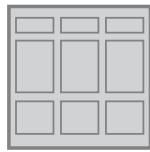
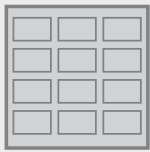
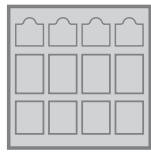















### DELIVERY CHARGES











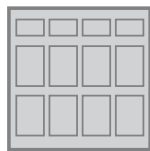

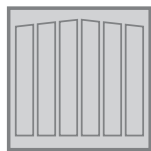

**ALL DOORS**

Delivery charges any quantity of door: £45.00 NET











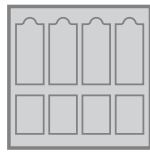



















Mainland England, Scotland and Wales only. Northern Ireland, Channel Islands, Isle of Man, and export delivery – charges on application.

Carriage charges and VAT to be added to all prices.











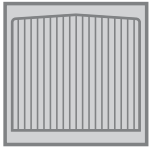









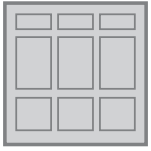









G.R.P. GLOSS WHITE															
	S-S   					M-M   					M-M     7+				
	CHELTENHAM					EDWARDIAN					EMSWORTH				
width	canopy gear		retractable gear			canopy gear		retractable gear			canopy gear		retractable gear		
															
1981mm (6'6")	1026	1274	1066	1314											
2134mm (7'0")	1026	1274	1066	1314		1056	1304	1096	1096		1078	1326	1118	1366	1579
2261mm (7'5")	1244	1493	1284	1533		1086	1335	1126	1375		1109	1358	1149	1398	1610
2286mm (7'6")	1244	1493	1284	1533		1086	1335	1126	1375		1109	1358	1149	1398	1610
2438mm (8'0")	1286	1535	1326	1575		1130	1379	1170	1419		1152	1401	1192	1441	1653
2743mm (9'0")								1509	1777						
3048mm (10'0")															
3353mm (11'0")															
3658mm (12'0")															
3962mm (13'0")															
4267mm (14'0")			1913	2180				*2074	*2342						
4572mm (15'0")								*2348	*2670						
4877mm (16'0")								*2695	*3016						
	SS widths: 6'6", 7'0", 7'5", 7'6", 8'0" or 14'0" SS heights: 6'6" or 7'0"					MtoM widths: 6'7" to 8'3"/ *13'5 1/4" to *15'3" MtoM heights: 6'3" to 7'0"					MtoM widths: 6'9" to 8'0" MtoM heights: 6'4" to 7'6"				
	SS widths (mm): 1981, 2134, 2261, 2286, 2438, 4267 SS heights (mm): 1981 or 2134					MtoM widths (mm): 2007 to *2515/ *4109 to *4648/ MtoM heights (mm): 1905 to 2134					MtoM widths (mm): 2057 to 2438 MtoM heights (mm): 1930 to 2286				

G.R.P. GLOSS WHITE															
	M-M    					M-M    7+					S-S    				
	GEORGIAN					GEORGIAN TALL					HAMBLE				
width	canopy gear		retractable gear			canopy gear		retractable gear			canopy gear		retractable gear		
															
1981mm (6'6")	1026	1274	1066	1314	1526			1168	1416		1026	1274	1066	1314	1525
2134mm (7'0")	1026	1274	1066	1314	1526			1168	1416		1026	1274	1066	1314	1525
2261mm (7'5")	1086	1335	1126	1375	1587			1229	1477		1244	1493	1284	1533	1745
2286mm (7'6")	1086	1335	1126	1375	1587			1229	1477		1244	1493	1284	1533	1745
2438mm (8'0")	1130	1379	1170	1419	1631			1273	1521		1286	1535	1326	1575	1787
2743mm (9'0")			1509	1777	2083			1606	1863						
3048mm (10'0")			1651	1919	2224			1736	2004						
3353mm (11'0")			1845	2113				1931	2199						
3658mm (12'0")			1988	2256				2074	2342						
3962mm (13'0")			2025	2293				2110	2378						
4267mm (14'0")			1982	2250				2068	2336				1913	2180	
4572mm (15'0")			2348	2670				2433	2755						
4877mm (16'0")			2695	3016				2781	3102						
	MtoM widths: 5'2" to 16'0" MtoM heights: 6'3" to 7'0"					MtoM widths: 6'6" to 16'0" MtoM heights: 6'9" to 7'8"					SS widths: 6'6", 7'0", 7'5", 7'6", 8'0" or 14'0" SS heights: 6'6" or 7'0"				
	MtoM widths (mm): 1575 to 4877 MtoM heights (mm): 1905 to 2134					MtoM widths (mm): 1981 to 4877 MtoM heights (mm): 2057 to 2337					SS widths (mm): 1981, 2134, 2261, 2286, 2438 or 4267 SS heights (mm): 1981 or 2134				

ONE PIECE UP & OVER DOORS G.R.P. GLOSS WHITE

G.R.P. GLOSS WHITE	 M-M    					 S-S    					 M-M     				
	NEWBURY					SOUTHWOOD					WIMBORNE				
	width	canopy gear		retractable gear			canopy gear		retractable gear			canopy gear		retractable gear	
															
1981mm (6'6")	1078	1326	1118	1366	1579	1056	1304	1096	1344		1186	1434	1226	1474	1686
2134mm (7'0")	1078	1326	1118	1366	1579	1056	1304	1096	1344		1186	1434	1226	1474	1686
2261mm (7'5")	1109	1358	1149	1398	1610	1086	1335	1126	1375		1304	1551	1344	1591	1804
2286mm (7'6")	1109	1358	1149	1398	1610	1086	1335	1126	1375		1304	1551	1344	1591	1804
2438mm (8'0")	1152	1401	1192	1441	1653	1130	1379	1170	1419		1348	1595	1388	1635	1848
2743mm (9'0")			1540	1808	2112								1645	1913	2217
3048mm (10'0")			1685	1952	2258								1789	2056	2362
3353mm (11'0")			1881	2149									1988	2256	
3658mm (12'0")			2027	2295									2132	2400	
3962mm (13'0")			2066	2334									2165	2432	
4267mm (14'0")			2087	2355				1913	2180				2187	2454	
4572mm (15'0")			2396	2717									2548	2869	
4877mm (16'0")			2750	3072											
	<b>MtoM widths: 6'6" to 16'0"</b> <b>MtoM heights: 6'6" to 7'0"</b>					<b>SS widths: 6'6", 7'0", 7'5", 7'6", 8'0" or 14'0"</b> <b>SS heights: 6'6" or 7'0"</b>					<b>MtoM widths: 5'2" to 15'0"</b> <b>MtoM heights: 6'2" to 7'0"</b>				
	<b>MtoM widths (mm): 1981 to 4877</b> <b>MtoM heights (mm): 1981 to 2134</b>					<b>SS widths (mm): 1981, 2134, 2261, 2286, 2438 or 4267</b> <b>SS heights (mm): 1981 or 2134</b>					<b>MtoM widths (mm): 1575 to 4572</b> <b>MtoM heights (mm): 1880 to 2134</b>				

ONE PIECE UP & OVER DOORS G.R.P. WOODGRAIN



G.R.P. WOODGRAIN	 M-M    					 M-M     					 M-M    				
	AVONBROOK					BLENHEIM					BOSTON				
	width	canopy gear		retractable gear			canopy gear		retractable gear			canopy gear		retractable gear	
															
1981mm (6'6")	1161	1409	1201	1449	1661								1302	1550	
2134mm (7'0")	1161	1409	1201	1449	1661	1735	1983	1775	2023	2235			1302	1550	
2261mm (7'5")	1337	1585	1377	1625	1837	1987	2235	2027	2275	2488			1479	1727	
2286mm (7'6")	1337	1585	1377	1625	1837	1987	2235	2027	2275	2488			1479	1727	
2438mm (8'0")	1381	1629	1421	1669	1881	2032	2280	2072	2320	2533			1523	1771	
2743mm (9'0")			1636	1904	2209			2235	2503	2807			1721	1989	
3048mm (10'0")			1779	2047	2352			2441	2708	3013			1865	2133	
3353mm (11'0")			*1951	*2219				2558	2826				2037	2305	
3658mm (12'0")			*2180	*2448									2265	2533	
3962mm (13'0")			2256	2524									2342	2610	
4267mm (14'0")			2278	2546				*2975	*3243				2363	2631	
4572mm (15'0")			2608	2929				3275	3597				2693	3014	
4877mm (16'0")			*2867	*3188									*2952	*3273	
	<b>MtoM widths: 6'6" to *10'4"</b> <b>&amp; *11'4" to *15'6"</b> <b>MtoM heights: 6'6" to 7'0"</b>					<b>MtoM widths: 6'7" to 11'0"</b> <b>&amp; *13'2" to 15'0"</b> <b>MtoM heights: 6'6" to 8'0"</b>					<b>MtoM widths: 6'0" to *15'6"</b> <b>MtoM heights: 6'9" to 8'0"</b>				
	<b>MtoM widths (mm): 1981 to *3150</b> <b>&amp; *3454 to *4724</b> <b>MtoM heights (mm): 1981 to 2134</b>					<b>MtoM widths (mm): 2007 to 3353</b> <b>&amp; *4013 to 4572</b> <b>MtoM heights (mm): 1981 to 2438</b>					<b>MtoM widths (mm): 1829 to *4724</b> <b>MtoM heights (mm): 2057 to 2438</b>				

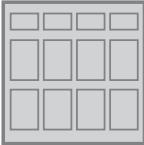
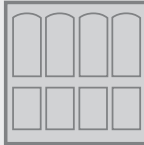
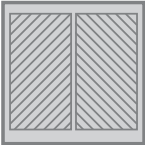

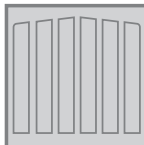
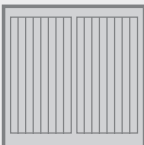
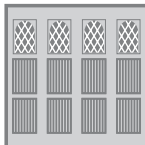
G.R.P. WOODGRAIN						 *black windows only									
	CANTERBURY (WIDE GRAIN)					COMPTON					COUNTY				
width	canopy gear		retractable gear			canopy gear		retractable gear			canopy gear		retractable gear		
	3 <sup>5</sup>	4 <sup>5</sup>	3 <sup>5</sup>	4 <sup>5</sup>	5 <sup>5</sup>	3 <sup>5</sup>	4 <sup>5</sup>	3 <sup>5</sup>	4 <sup>5</sup>	5 <sup>5</sup>	3 <sup>5</sup>	4 <sup>5</sup>	3 <sup>5</sup>	4 <sup>5</sup>	5 <sup>5</sup>
1981mm (6'6")	1161	1409	1201	1449	1661										
2134mm (7'0")	1161	1409	1201	1449	1661	1161	1409	1201	1449	1749	1161	1409	1201	1449	
2261mm (7'5")	1337	1585	1377	1625	1837	1337	1585	1377	1625	1925	1337	1585	1377	1625	
2286mm (7'6")	1337	1585	1377	1625	1837	1337	1585	1377	1625	1925	1337	1585	1377	1625	
2438mm (8'0")	1381	1629	1421	1669	1881	1381	1629	1421	1669	1969	1381	1629	1421	1669	
2743mm (9'0")			1636	1904	2209										
3048mm (10'0")			1779	2047	2352										
3353mm (11'0")			1951	2219									1951	2219	
3658mm (12'0")			2180	2448									2180	2448	
3962mm (13'0")			2256	2524									2256	2524	
4267mm (14'0")			2278	2546				*2363	*2631				2278	2546	
4572mm (15'0")			2608	2929				2693	3014				2608	2929	
4877mm (16'0")			2867	3188									*2867	*3188	
	<b>MtoM widths: 5'0" to 16'0"</b> <b>MtoM heights: 6'3" to 7'0"</b>					<b>MtoM widths: 6'8" to 8'0"</b> <b>&amp; 13'6" to 15'0"</b> <b>MtoM heights: 6'3" to 7'6"</b>					<b>MtoM widths: 6'11" to 8'0"</b> <b>&amp; *12'3" to 15'3"</b> <b>MtoM heights: 6'3" to 7'0"</b>				
	<b>MtoM widths (mm): 1524 to 4877</b> <b>MtoM heights (mm): 1905 to 2134</b>					<b>MtoM widths (mm): 2032 to 2438</b> <b>&amp; 4114 to 4572</b> <b>MtoM heights (mm): 1905 to 2286</b>					<b>MtoM widths (mm): 2108 to 2438</b> <b>&amp; *3743 to 4648</b> <b>MtoM heights (mm): 1905 to 2134</b>				

G.R.P. WOODGRAIN															
	ELSTEAD					FRENSHAM (WIDE GRAIN)					GOTHIC				
width	canopy gear		retractable gear			canopy gear		retractable gear			canopy gear		retractable gear		
	3 <sup>5</sup>	4 <sup>5</sup>	3 <sup>5</sup>	4 <sup>5</sup>	5 <sup>5</sup>	3 <sup>5</sup>	4 <sup>5</sup>	3 <sup>5</sup>	4 <sup>5</sup>	5 <sup>5</sup>	3 <sup>5</sup>	4 <sup>5</sup>	3 <sup>5</sup>	4 <sup>5</sup>	5 <sup>5</sup>
1981mm (6'6")											1868	2116	1908	2156	2367
2134mm (7'0")	1161	1409	1201	1449	1661	1161	1409	1201	1449	1661	1868	2116	1908	2156	2367
2261mm (7'5")	1337	1585	1377	1625	1837	1337	1585	1377	1625	1837	2120	2368	2160	2408	2620
2286mm (7'6")	1337	1585	1377	1625	1837	1337	1585	1377	1625	1837	2120	2368	2160	2408	2620
2438mm (8'0")	1381	1629	1421	1669	1881	1381	1629	1421	1669	1881	2163	2411	2203	2451	2663
2743mm (9'0")			*1636	*1904	2209								2462	2729	3035
3048mm (10'0")													2667	2935	3241
3353mm (11'0")													2785	3053	
3658mm (12'0")													2949	3217	
3962mm (13'0")													3106	3374	
4267mm (14'0")			*2233	*2501				*2233	*2501				3127	3395	
4572mm (15'0")			2608	2929				2608	2929				3490	3811	
4877mm (16'0")								*2867	*3188				3910	4231	
	<b>MtoM widths: 6'9" to *8'4"</b> <b>&amp; *13'1" to *15'0"</b> <b>MtoM heights: 6'4" to 7'6"</b>					<b>MtoM widths: 6'8" to 8'0" &amp; *13'9/2" to *15'3"</b> <b>MtoM heights: 6'0" to 6'6" &amp; 6'7" to 7'0"</b> <b>(up to 8'0" wide)</b> <b>6'4" to 7'0" (from 13'9/2" to 15'3")</b>					<b>MtoM widths: 5'0" to 16'0"</b> <b>MtoM heights: 6'4" to 7'0"</b>				
	<b>MtoM widths (mm): 2057 to *2540</b> <b>&amp; *3988 to *4572</b> <b>MtoM heights (mm): 1930 to 2286</b>					<b>MtoM widths (mm): 2032 to 2438 &amp; *4204 to *4648</b> <b>MtoM heights (mm): 1829 to 1981</b> <b>and 2007 to 2134 (up to 2438 wide)</b> <b>1930 to 2134 (from 4204 to 4648 wide)</b>					<b>MtoM widths (mm): 1524 to 4877</b> <b>MtoM heights (mm): 1930 to 2134</b>				

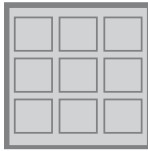
\* Frensham – Note the feature height of single doors up to 6'6" (1981mm) high, over 6'7" (2007mm) high and the double doors all vary, please check for doors to be fitted side by side.



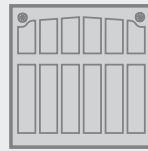
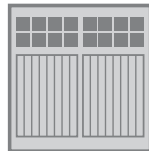



G.R.P. WOODGRAIN															
	MAJESTIC					PEMBROKE (WIDE GRAIN)					PEMBROKE TALL (WIDE GRAIN)				
	width	canopy gear		retractable gear			canopy gear		retractable gear			canopy gear		retractable gear	
	3 <sup>3</sup>	4 <sup>4</sup>	3 <sup>3</sup>	4 <sup>4</sup>	5 <sup>5</sup>	3 <sup>3</sup>	4 <sup>4</sup>	3 <sup>3</sup>	4 <sup>4</sup>	5 <sup>5</sup>	3 <sup>3</sup>	4 <sup>4</sup>	3 <sup>3</sup>	4 <sup>4</sup>	5 <sup>5</sup>
1981mm (6'6")	1139	1386	1179	1426											
2134mm (7'0")	1139	1386	1179	1426		1161	1409	1201	1449	1661			1302	1550	
2261mm (7'5")	1171	1419	1211	1459		1337	1585	1377	1625	1837			*1479	*1727	
2286mm (7'6")	1171	1419	1211	1459		1337	1585	1377	1625	1837			1479	1727	
2438mm (8'0")	1214	1462	1254	1502		1381	1629	1421	1669	1881			1523	1771	
2743mm (9'0")								1636	1904	2209			*1721	*1989	
3048mm (10'0")								1779	2047	2352			*1865	*2133	
3353mm (11'0")								1951	2219				2037	2305	
3658mm (12'0")								2180	2448				*2265	*2533	
3962mm (13'0")								2256	2524				2342	2610	
4267mm (14'0")								2278	2546				*2363	*2631	
4572mm (15'0")								2608	2929				2693	3014	
4877mm (16'0")								*2867	*3188				*2952	*3273	
	SS widths: 6'6", 7'0", 7'5", 7'6", 8'0" SS heights: 6'6" or 7'0"					MtoM widths: 6'10" to *15'6" MtoM heights: 6'3" to 7'0"					MtoM widths: 6'10" to *8'7", *9'2" to 11'0", *11'6" to *13'4", 14'0" to *15'9" MtoM heights: 7'0" to 8'0"				
	SS widths (mm): 1981, 2134, 2261, 2286, 2438 SS heights (mm): 1981 or 2134					MtoM widths (mm): 2083 to *4724 MtoM heights (mm): 1905 to 2134					MtoM widths (mm): 2083 to *2616, *2794 to 3353, *3505 to *4064 & 4267 to *4801 MtoM heights (mm): 2134 to 2438				

G.R.P. WOODGRAIN															
	PURBECK					SHERBORNE					SHERWOOD (WIDE GRAIN)				
	width	canopy gear		retractable gear			canopy gear		retractable gear			canopy gear		retractable gear	
	3 <sup>3</sup>	4 <sup>4</sup>	3 <sup>3</sup>	4 <sup>4</sup>	5 <sup>5</sup>	3 <sup>3</sup>	4 <sup>4</sup>	3 <sup>3</sup>	4 <sup>4</sup>	5 <sup>5</sup>	3 <sup>3</sup>	4 <sup>4</sup>	3 <sup>3</sup>	4 <sup>4</sup>	5 <sup>5</sup>
1981mm (6'6")															
2134mm (7'0")	1370	1617	1410	1657	1871	1161	1409	1201	1449	1661	1370	1617	1410	1657	1871
2261mm (7'5")	1411	1658	1451	1698	1911	1337	1585	1377	1625	1837	*1411	*1658	*1451	*1698	*1911
2286mm (7'6")	1411	1658	1451	1698	1911	1337	1585	1377	1625	1837	1411	1658	1451	1698	1911
2438mm (8'0")	1454	1701	1494	1741	1955	1381	1629	1421	1669	1881	1454	1701	1494	1741	1955
2743mm (9'0")			*1573	*1841	*2147			1636	1904	2209			*1573	*1841	*2147
3048mm (10'0")								*1779	*2047	*2352					
3353mm (11'0")															
3658mm (12'0")								*2180	*2448						
3962mm (13'0")								2256	2524						
4267mm (14'0")			*2307	*2575				2233	2501				2307	2575	
4572mm (15'0")			2590	2911				2608	2929				2590	2911	
4877mm (16'0")													2844	3165	
	MtoM widths: 6'10" to *8'4" & *13'6" to 15'0" MtoM heights: 6'2" to 7'0"					MtoM widths: 6'7 1/4" to 9'4" & *11'3" to 13'0" & 13'4 1/2" to 15'0" MtoM heights: 6'6" to 7'0"					MtoM widths: *7'0" & *7'2" to *8'6" & *13'11" to 16'0" MtoM heights: 6'4" to 7'0"				
	MtoM widths: 2083 to *2540 & *4115 to 4572 MtoM heights: 1880 to 2134					MtoM widths (mm): 2026 to 2845 & *3429 to 3962 & *4078 to 4572 MtoM heights (mm): 1981 to 2134					MtoM widths (mm): *2134 & *2184 to *2591 & *4242 to 4877 MtoM heights (mm): 1930 to 2134				

width	TUDOR					WARWICK					YORK				
	canopy gear		retractable gear			canopy gear		retractable gear			canopy gear		retractable gear		
	3 <sup>5</sup>	4 <sup>5</sup>	3 <sup>5</sup>	4 <sup>5</sup>	5 <sup>5</sup>	3 <sup>5</sup>	4 <sup>5</sup>	3 <sup>5</sup>	4 <sup>5</sup>	5 <sup>5</sup>	3 <sup>5</sup>	4 <sup>5</sup>	3 <sup>5</sup>	4 <sup>5</sup>	5 <sup>5</sup>
1981mm (6'6")	1735	1983	1775	2023	2235	1161	1409	1201	1449	1661	1161	1409	1201	1449	1661
2134mm (7'0")	1735	1983	1775	2023	2235	1161	1409	1201	1449	1661	1161	1409	1201	1449	1661
2261mm (7'5")	1987	2235	2027	2275	2488	1337	1585	1377	1625	1837	1337	1585	1377	1625	1837
2286mm (7'6")	1987	2235	2027	2275	2488	1337	1585	1377	1625	1837	1337	1585	1377	1625	1837
2438mm (8'0")	2032	2280	2072	2320	2533	1381	1629	1421	1669	1881	1381	1629	1421	1669	1881
2743mm (9'0")			2235	2503	2807			1636	1904	2209			1636	1904	2209
3048mm (10'0")			2441	2708	3013			1779	2047	2352			1779	2047	2352
3353mm (11'0")			2558	2826				1951	2219				1951	2219	
3658mm (12'0")			2722	2990				2180	2448				2180	2448	
3962mm (13'0")			2880	3147				2256	2524				2256	2524	
4267mm (14'0")			2901	3168				2278	2546				2278	2546	
4572mm (15'0")			3275	3597				2608	2929				2608	2929	
4877mm (16'0")			3695	4017				2867	3188				2867	3188	
	<b>MtoM widths: 5'0" to 16'0"</b> <b>MtoM heights: 6'4" to 7'0"</b>					<b>MtoM widths: 6'6" to 16'0"</b> <b>MtoM heights: 6'6" to 7'0"</b>					<b>MtoM widths: 5'0" to 16'0"</b> <b>**MtoM heights: 5'10" to 8'0"</b>				
	<b>MtoM widths (mm): 1524 to 4877</b> <b>MtoM heights (mm): 1930 to 2134</b>					<b>MtoM widths (mm): 1981 to 4877</b> <b>MtoM heights (mm): 1981 to 2134</b>					<b>MtoM widths (mm): 1524 to 4877</b> <b>**MtoM heights (mm): 1778 to 2438</b>				

**\*\*York – Minimum heights** 5'10" (1778mm) on Safelift canopy gear, 6'0" (1829mm) on Maximiser retractable gear, 6'1" (1854mm) on Double or Heavy retractable gear.

KEY:  MADE TO MEASURE  WINDOWS AVAILABLE  HEIGHTS OVER 2134MM AVAILABLE

	STYLE	Classic	Exclusive	Configuration	Size & Window Availability
	CHELTHENHAM GLOSS WHITE	975	1300	2/3:1/3	Widths 1981mm - 2438mm (6'6" - 8'0") Heights 1880mm - 2134mm (6'2" - 7'0")   * Two Point Eurolock as standard
	EDWARDIAN GLOSS WHITE	975	1300	2/3:1/3	Widths 2007mm - 2438mm (6'7" - 8'0") Heights 1880mm - 2134mm (6'2" - 7'0")  
	EMSWORTH GLOSS WHITE	975	1300	50:50	Widths 2007mm - 2438mm (6'7" - 8'0") Heights 1905mm - 2286mm (6'3" - 7'6")  
	GRAFTON GLOSS WHITE	975	1350	50:50	Widths 2083mm - 2438mm (6'10" - 8'0") Heights 1905mm - 2286mm (6'3" - 7'6")   
	NEWBURY GLOSS WHITE	975	1300	50:50	Widths 1981mm - 2438mm (6'6" - 8'0") Heights 1880mm - 2134mm (6'2" - 7'0")  * Two Point Eurolock as standard
	BOSTON WOODGRAIN	1055	1350	2/3:1/3	Widths 1778mm - 2286mm (5'10" - 7'6") Heights 2134mm - 2438mm (7'0" - 8'0")    * Two Point Eurolock as standard
	FRENSHAM WOODGRAIN	1055	1350	50:50	Widths 2007mm - 2438mm (6'7" - 8'0") Heights 1727mm - 2134mm (5'8" - 7'0")  Not available between heights 1981mm - 2032mm ( 6'6" - 6'8")

## SPECIFICATION

### CLASSIC

- Choice of 50mm (standard) or 65mm (optional) Plastisol Frame\*
- 4 steel hinges per side
- Silver effect nightlatch with white lock body, single point latching
- Pair of white polyester painted stays
- Two shoot bolts (inactive leaf)
- Draft strip to all 3 sides
- Bottom weather strip
- Outward opening, right hand leading leaf viewed from outside (Left hand leading or inward opening available - see options right)

### EXCLUSIVE

- Choice of 50mm (standard) or 65mm (optional) Plastisol Frame\*
- 4 brass effect anti-drop anchored dog bolt hinges per side
- Eurocylinder nightlatch with double throw deadbolt and 3 point latching
- Pair of white polyester painted stays
- Two shoot bolts (inactive leaf)
- Draft strip to all 3 sides
- Bottom weather strip
- Outward opening, right hand leading leaf viewed from outside
- Luxury white GRP wipe clean flat panel finish to rear of each door leaf

- \* 65mm frame has 65mm uprights and a 68mm head
- \* 50mm frame has 50mm uprights and a 38mm head

### GENERAL INFORMATION

- **Handle Positions**  
These will vary between doors of different sizes of the same style.
- **Glazed G.R.P. Doors**  
All window design doors are fitted with standard black (opaque) windows, which cannot be seen through. Clear and stippled translucent windows are available as options on Classic doors only.
- **Matching Woodgrain G.R.P. Doors**  
Where doors are to be fitted in close proximity and are required to be coloured as closely as possible, it is vital that they are clearly requested 'To Match' at time of ordering.
- **Made to Measure Door Prices**  
There is no additional charge for made to measure sizes. **Note:** please refer to the size parameter details beside the price for the actual minimum / maximum door size available.
- **Opening Size**  
All door sizes stated in this price list refer to internal frame dimensions. Due to the bespoke nature of Wessex garage doors we regret we can not accept order cancellations.
- **Top & Bottom Rails & End Stiles**  
Top, bottom, centre and end stiles (edges) may vary in width or height between doors of the same style depending on size ordered. This is to enable us to cater for your particular size of garage door. If in doubt, please refer to Wessex before ordering.
- **Translucency**  
Translucency of the door panel on Classic doors may vary when viewed from the inside on a bright day due to variations in laminate thickness. This does not represent a manufacturing defect and overall performance is not affected.













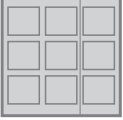





### DELIVERY CHARGES

#### ALL DOORS

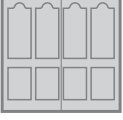
Delivery charges any quantity of door: £45.00 NET

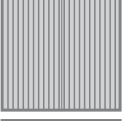

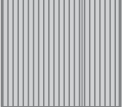
Mainland England, Scotland and Wales only. Northern Ireland, Channel Islands, Isle of Man, and export delivery – charges on application.  
Carriage charges and VAT to be added to all prices.

KEY:  MADE TO MEASURE  WINDOWS AVAILABLE  HEIGHTS OVER 2134MM AVAILABLE

	STYLE	Classic	Exclusive	Configuration	Size & Window Availability
	LOXWOOD WOODGRAIN	1055	1400	50:50	Widths 2083mm - 2438mm (6'10" - 8'0") Heights 1905mm - 2286mm (6'3" - 7'6")  
	MAJESTIC WOODGRAIN	1000	1350	2/3:1/3	Widths 1981mm - 2438mm (6'6" - 8'0") Heights 1854mm - 2134mm (6'1" - 7'0")  
	RUSHMOOR WOODGRAIN	1055	1400	50:50	Widths 2083mm - 2438mm (6'10" - 8'0") Heights 1905mm - 2286mm (6'3" - 7'6")   
	SHERWOOD WOODGRAIN	1135	1450	50:50	Widths 2134mm - 2438mm (7'0"* - 8'0") Heights 1905mm - 2134mm (6'3" - 7'0")   Available in widths 2134mm and 2184mm - 2438mm (7'0" and 7'2" - 8'0")
	WARWICK WOODGRAIN	1055	1350	50:50	Widths 1981mm - 2438mm (6'6" - 8'0") Heights 1880mm - 2134mm (6'2" - 7'0")  * Two Point Eurolock as standard
	YORK WOODGRAIN	975	1350	50:50	Widths 1219mm - 2438mm (4'0" - 8'0") Heights 1778mm - 2438mm (5'10" - 8'0")  
	YORK WOODGRAIN	975	1350	2/3:1/3	Widths 1524mm - 2438mm (5'0" - 8'0") Heights 1778mm - 2438mm (5'10" - 8'0")  

## OPTIONS

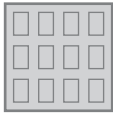
LOCKING		
Eurolock multi-point latch upgrade to standard Classic range night latch		140
Mechanical digital lock upgrade to nightlatch on Classic range - specify brass effect or chrome effect		100
Brass effect hinge upgrade to Classic range		40
Left hand opening / Inward opening - only available on doors with Euro-style locking and supplied without stays		55 / 95
WINDOWS (Clear or stippled available on Classic range only)		
*Black windows - Cheltenham, Boston, Edwardian, Emsworth, Grafton, Majestic, Rushmoor, Sherborne		125
*Clear or stippled windows - Cheltenham, Boston, Edwardian, Emsworth, Grafton, Majestic, Rushmoor, Sherborne / Sherwood		255 / 335
*Available with border, diamond or square leading - please state when ordering		
FRAMES		
50/65mm white, black or van dyke brown Plastisol frame		Standard / 20
50/65mm Golden Oak or Rosewood laminate frame <sup>#</sup>		30 / 30
Unframed (deletion cost)		-40
Plastisol frame colours are: White BS00E55, Brown (Van dyke brown) BS08B29, Black BS00E53		
<sup>#</sup> Woodgrain Golden Oak and Rosewood are polymer laminates and provide a good match to Honey Beech and Dark Mahogany respectively. Please request a sample for confirmation.		
COLOURS		
Red / green / blue solid woodgrain colour option		250

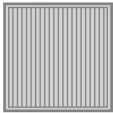
STEEL							
STANDARD SINGLE SIZE		ALTON		NORFOLK II		SUFFOLK II	
width & height		canopy gear	retractable gear	canopy gear	retractable gear	canopy gear	retractable gear
1981 x 1981	6'6"x6'6"	626	666	432	472	491	531
1981 x 2134	6'6"x7'0"	639	689	438	478	492	532
2083 x 1905	6'10"x 6'3"	606	646	445	485	504	544
2083 x 1930	6'10" x 6'4"	606	646	448	488	498	538
2083 x 1956	6'10" x 6'5"	606	646	454	494	513	553
2083 x 1981	6'10" x 6'6"	606	646	461	501	513	553
2083 x 2134	6'10" x 7'0"	638	678	477	517	522	562
2108 x 1981	6'11" x 6'6"	636	676	461	501	519	559
2108 x 2134	6'11" x 7'0"	667	707	477	517	524	564
2134 x 1905	7'0" x 6'3"	606	646	461	501	516	556
2134 x 1930	7'0" x 6'4"	606	646	453	493	506	546
2134 x 1956	7'0" x 6'5"	638	678	466	506	510	550
2134 x 1981	7'0" x 6'6"	604	644	419	459	489	529
2134 x 2134	7'0" x 7'0"	638	678	455	495	503	543
2222 x 1930	7'3.5" x 6'4"	677	717	477	517	540	580
2222 x 1981	7'3.5" x 6'6"	682	722	482	522	530	570
2222 x 2134	7'3.5" x 7'0"	684	724	486	526	535	575
2261 x 1981	7'5" x 6'6"	700	740	491	531	551	591
2261 x 2134	7'5" x 7'0"	827	867	553	593	608	648
2286 x 1930	7'6" x 6'4"	677	717	480	520	535	575
2286 x 1981	7'6" x 6'6"	682	722	479	519	534	574
2286 x 2134	7'6" x 7'0"	797	837	548	588	586	626
2438 x 1905	8'0" x 6'3"	827	867	529	569	611	651
2438 x 1930	8'0" x 6'4"	816	856	553	593	629	669
2438 x 1981	8'0" x 6'6"	816	856	553	593	629	669
2438 x 2134	8'0" x 7'0"	871	911	564	604	656	696

STANDARD DOUBLE SIZE		ALTON		NORFOLK II		SUFFOLK II	
width & height							
2743 x 1981/2134	9'0" x 6'6"/7'0"	-	-	-	856	-	930
3048 x 1981/2134	10'0" x 6'6"/7'0"	-	-	-	1076	-	1018
3353 x 1981/2134	11'0" x 6'6"/7'0"	-	-	-	1205	-	1307
3658 x 1981/2134	12'0" x 6'6"/7'0"	-	-	-	1319	-	1378
3962 x 1981/2134	13'0" x 6'6"/7'0"	-	-	-	1403	-	1469
4267 x 1981/2134	14'0" x 6'6"/7'0"	-	-	-	1322	-	1340
4420 x 1981/2134	14'6" x 6'6"/7'0"	-	-	-	1674	-	1654
4572 x 1981/2134	15'0" x 6'6"/7'0"	-	-	-	1729	-	1693
4877 x 1981/2134	16'0" x 6'6"/7'0"	-	-	-	1782	-	1879
		MtoM widths: 5'10" to 14'0" MtoM heights: 6'1" to 7'6"		MtoM widths: 5'10" to 14'0" MtoM heights: 6'1" to 7'6"		MtoM widths: 6'0" to 8'0" MtoM heights: 6'6" to 7'0"	
		MtoM widths (mm): 1778 to 4877 MtoM heights (mm): 1854 to 2286		MtoM widths (mm): 1778 to 4877 MtoM heights (mm): 1854 to 2286		MtoM widths (mm): 1829 to 2438 MtoM heights (mm): 1981 to 2134	

MADE TO MEASURE SIZES **Take the next standard size up from the table above and add: £100 single doors / £ 200 double doors**

Doubles = all doors over 8'0"/2438 mm. For heights over 2134mm up to 2286mm, add the supplement to 2134mm height price.<sup>o</sup>

<sup>o</sup>Single door sizes in this range are only available with maximizer gear - the £100 must be added to the maximizer retractable door price.

Check size availability with the table above.

GEAR RESTRICTIONS UP & OVER DOORS  
MINIMUM HEIGHTS

5'10" (1778mm) on Safelift canopy gear,  
6'0" (1829mm) on Maximiser retractable gear or  
6'1" (1854mm) on Double or Heavy retractable gear.

FINISHING & MAINTENANCE

• Steel Doors and Frames

Primed, steel doors and steel frames require a suitable undercoat and topcoat to be applied shortly after delivery in order that the product warranty is not invalidated.



TIMBER	ELIZABETHAN II & RALEIGH II		VERTICAL II & LATERAL II	
	canopy gear	retractable gear	canopy gear	retractable gear
width & height				
2134mm x 1981mm (7'0" x 6'6")	996	1036	1153	1193
2134mm x 2134mm (7'0" x 7'0")	998	1038	1153	1193
2286mm x 2134mm (7'6" x 7'0")	1011	1051	1189	1229
2286mm x 2286mm (7'6" x 7'6")	1013	1053	1228	1268
2438mm x 1981mm (8'0" x 6'6")	1024	1064	1269	1309
2438mm x 2134mm (8'0" x 7'0")	1026	1066	1294	1334
4267mm x 1981mm (14'0" x 6'6")	-	2433	-	2546
4267mm x 2134mm (14'0" x 7'0")	-	2435	-	2546
<b>MADE TO MEASURE</b>				
sizes up to	ELIZABETHAN II & RALEIGH II		VERTICAL II & LATERAL II	
	canopy gear	retractable gear	canopy gear	retractable gear
2134mm x 2134mm (7'0" x 7'0")	995	1035	1224	1264
2438mm x 2134mm (8'0" x 7'0")	1250	1290	1328	1368
2743mm x 2134mm (9'0" x 7'0")	-	1730	-	1942
3048mm x 2134mm (10'0" x 7'0")	-	1770	-	1963
3353mm x 2134mm (11'0" x 7'0")	-	2284	-	2327
3658mm x 2134mm (12'0" x 7'0")	-	2309	-	2558
3962mm x 2134mm (13'0" x 7'0")	-	2509	-	2790
4267mm x 2134mm (14'0" x 7'0")	-	2661	-	2641
4572mm x 2134mm (15'0" x 7'0")	-	3094	-	3226
4877mm x 2134mm (16'0" x 7'0")	-	3312	-	3460
	MtoM widths: 5'10" to 16'0" MtoM heights: 5'10" to 7'6"		MtoM widths: 5'10" to 16'0"* MtoM heights: 5'10" to 7'6"* *(Lateral only 10'0")	
	MtoM widths (mm): 1778 to 4877 MtoM heights (mm): 1778 to 2286		MtoM widths (mm): 1778 to 4877* (*Lateral only 3048) MtoM heights (mm): 1778 to 2286	



**For doors over 2134mm (7'0") add to the prices above: £100 single doors / £ 200 double doors**

Doubles = all doors over 8'0"/2438 mm. °Single door sizes in this range are only available with maximizer gear - the £100 must be added to the maximizer retractable door price.

Check size availability with the table above.

All timber doors are supplied base coat treated and will require a single finishing coat on site.\* All timber doors should be treated immediately upon installation.\*Always follow the stain manufacturer's guidelines.

**FINISHING & MAINTENANCE**

• **Timber Doors**

These need to be treated immediately upon delivery to site with a suitable clear or coloured stain to avoid marking or discolouration and to avoid invalidation of the warranty.

**FRAMES**

**Steel Frames**

**Canopy Doors**

Suitable for all single doors up to 2438mm x 2134mm (8'0" x 7'0"). Frames are pre-fitted to the door. Standard frame jambs are 54mm (2.1 8") wide (optional jambs of 68mm (2.2 3") available on request) and head is 68mm (2.2 3") high. Minimum door height 1778mm (5'10").

When an Autoglide electric operator is to be specified together with a Wessex Quick Fit Canopy Standard Steel Frame, the frame must be fitted either behind the brickwork or with the rear of the frame flush with the rear of the brickwork.

**Single Retractable Doors on Maxi-mizer Door Gear**

Suitable for all single doors on Maxi-mizer gear up to 2438mm x 2286mm (8'0" x 7'6") except 5 crown up to 2286mm x 2134mm (7'6" x 7'0"). Frames are pre-fitted to the door. Jambs are 68mm (2.2 3") wide and head is 68mm (2.2 3") high. Minimum door height 1829mm (6'0").

**Double Retractable Doors on Double or Heavy Door Gear**

Suitable for all double doors on double or heavy gear up to 4877mm x 2438mm (16'0" x 8'0"). Frames are supplied separate and NOT pre-fitted to doors. Jambs are 68mm (2.2 3") wide and head is 68mm (2.2 3") high. Minimum door height 1854mm (6'1").

**UPVC Timber Cored Frame Sections**

Supplied in three sections with mitred corners, these frames are 70mm x 70mm (2.3 4" x 2.3 4") for doors up to 4877mm x 2438mm (16'0" wide x 8'0" high). Frames include a fixing groove and cover strip for concealed fixing. Frames are available in White or Woodgrain laminate finish in Rosewood and Golden Oak (closely matches G.R.P. Dark Mahogany and Honey Beech colour finishes). Frame sections are not pre-fitted and are supplied loose for fitment to any door.

**UPVC Timber Cored Uprights Only (per pair)**

Uprights are available in 70mm x 70mm (2.3 4" x 2.3 4") for doors up to 2438mm (8'0") high. Uprights are available in finishes as uPVC frame sections above. Uprights are not pre-fitted and are supplied loose for fitment to any door.

**G.R.P. Frame Sections**

Supplied in three sections, these frames are in two sizes 70mm x 70mm or 95mm x 70mm (2.3 4" x 2.3 4" or 3.3 4" x 2.3 4") for doors up to 4877mm x 2438mm (16'0" wide x 8'0" high). Frames are available in Gloss White or Woodgrain finish in standard colours. Frame sections are not pre-fitted and are supplied loose for fitment to any door.

**Facias**

Finished G.R.P. sections designed to match your G.R.P. door for filling in above or beside the opening. Facias are available in Gloss White or Woodgrain finish in standard colours in widths between 50mm to 305mm (2" to 12"). Minimum length is 1829mm (6'0").

NB. Lengths over 3048mm (10'0") will be supplied in two sections.

**Uprights Only (per pair)**

Uprights are available in two sizes 70mm x 70mm or 95mm x 70mm (2.3 4" x 2.3 4" or 3.3 4" x 2.3 4") for doors up to 2438mm (8'0") high. Uprights are available in Gloss White or Woodgrain finish in standard colours. Uprights are not pre-fitted and are supplied loose for fitment to any door.

Steel Frames (Standard Sizes or Made to Measure)	White Primed	Low maintenance white, brown or black Plastisol / Woodgrain *** Golden oak or Rosewood
54mm to suit Canopy doors SafeLift gear pre-fitted to doors	95	110/120
68mm to suit Canopy and Retractable doors with Safelift /Maxi-mizer gear pre-fitted to doors	110	125/135
To suit Retractable doors, Double door gear supplied loose NOT pre-fitted to doors	190	205/215

Plastisol frame colours are; White BS00E55, Brown (Van dyke brown) BS08B29, Black BS00E53

\*\*\*Woodgrain Golden Oak and Rosewood are polymer laminates and provide a reasonable match to Honey Beech and Dark Mahogany respectively. Please request a sample for confirmation.

UPVC Timber Cored Frames c/w fixing groove & cover strip		White	Woodgrain Rosewood or Golden Oak (closely matches G.R.P Dark Mahogany & Honey Beech)
Width	Height		
Up to 11ft (3353mm)	Up to 8ft (2438mm)	176	220
Up to 16ft (4877mm)	Up to 8ft (2438mm)	220	286
Jambs only	Up to 8ft (2438mm)	121	160

G.R.P. Frames (3 section)	Up to 2134mm (7'0")	2134mm (7'0") - 3353mm (11'0")	3353mm (11'0") - 4572mm (15'0")	4572mm (15'0") - 4877mm (16'0")
Gloss White 70mm x 70mm	337	396	451	528
Gloss White 95mm x 70mm	380	466	512	589
Woodgrain 70mm x 70mm	364	425	484	562
Woodgrain 95mm x 70mm	416	483	550	635

Colour option for blue, green and red frames add \$55 per frame - Please note we are unable to supply a colour co-ordinated headbead with these colours.

A colour co-ordinated headbead is supplied with G.R.P. frames. It is not grained and therefore is similar in colour, but not identical, to the grained frame section.

NB. lengths over 4267mm (14'0") will be supplied in 2 sections.

Extra lengths available at £18 per metre.

G.R.P. Facias	Width	Price per 305mm (12")
Gloss White	2" to 12" (50mm to 305mm)	25
Woodgrain	2" to 12" (50mm to 305mm)	26

G.R.P. Uprights (per pair)	Height up to 2438mm (8'0")
Gloss White 70mm x 70mm	212
Gloss White 95mm x 70mm	248
Woodgrain 70mm x 70mm	248
Woodgrain 95mm x 70mm	271

ALL DOORS			
Brass effect finish lock (upgrade from black lock)			42 per set
Adjustable deep reveal brackets (for use with retractable gear only)	Size 1	0 - 152mm (0" - 6")	49 per pair
	Size 2	152 - 305mm (6" - 12")	52 per pair
	Size 3	305 - 457mm (12" - 18")	54 per pair
	Size 4	457 - 610mm (18" - 24")	57 per pair
Draught Strip (bottom edge brush strip to help prevent leaves, dirt and draughts blowing into your garage) single/double doors			39 / 75

G.R.P. DOORS	
Black windows on single doors up to 2438mm (8'0") wide (please specify leading requirements)	125 per door
Black windows on double doors over 2438mm (8'0") wide (please specify leading requirements)	250 per door
Clear or Stippled windows on single doors up to 2438mm (8'0") (please specify leading requirements)	255 per door
Clear or Stippled windows on double doors over 2438mm (8'0") (please specify leading requirements)	510 per door
Clear or Stippled windows on single doors up to 2438mm (8'0") (please specify leading requirements)	280 per door
Clear or Stippled windows on double doors over 2438mm (8'0") (please specify leading requirements)	560 per door
Clear or Stippled windows on single doors up to 2438mm (8'0") (please specify leading requirements)	335 per door
Clear or Stippled windows on double doors over 2438mm (8'0") (please specify leading requirements)	670 per door
Colour Option available for Woodgrain doors only - blue, green and red for single doors up to 2438mm (8'0") wide	250 per door
Colour Option available for Woodgrain doors only - blue, green and red for double doors over 2438mm (8'0") wide	370 per door

## ELECTRIC OPERATORS

Autoglide (For canopy doors)	450
DC-550NIII (For retractable and sectional doors)	357
DC-650NIII (For retractable and sectional doors)	430
DC-800NIII (For retractable and sectional doors)	473

## ELECTRIC OPERATOR ACCESSORIES

	DC-550 / 650 / 800NIII	Autoglide
Beam break	70	-
Kevlar Belt drive	48	-
Chain drive	0	-
Electric key switch control	41	41
Exterior digital keyless entry pad	93	87
Emergency exterior release kit	31	36
External receiver	102	-
Light relay	70	-
Mini key ring transmitter (2 channel)	-	59
Mini transmitter (4 channel)	49	-
Three function wall control	37	-
Medium extended toothed belt / chain drive boom (DC-650/800NIII)	21	-
Medium extended toothed Kevlar belt drive boom (DC-650/800NIII)	74	-
Long extended chain drive boom (DC-800NIII)	53	-
Long extended Kevlar belt drive boom (DC-800NIII)	95	-
Two piece version of booms	0	-

## OPERATOR TECHNICAL SPECIFICATION

Feature	Autoglide	DC - 550NIII	DC - 650NIII	DC - 800NIII
Door suitability	SafeLift Canopy gear and CD45 & CD Professional Trackless Canopy gear retro fit	Retractable and sectional	Retractable and sectional	Retractable and sectional
Opening force	400N	550N with electronic 'Soft Start & Stop'	650N electronic "Soft Start and Stop"	800N electronic "Soft Start and Stop"
Normal running load	60W (energy saving circuit) plus 120W light output	200W max (with 230V, 40 Watt light on)	200W max (with 230V, 40 Watt light on)	250W max (with 230V, 40 Watt light on)
"Stand-by" load	7 Watts (energy saving circuit)	<4 Watts (energy saving circuit)	<4 Watts (energy saving circuit)	<4 Watts (energy saving circuit)
Motor	24V DC with thermal overload protection on transformer	24V DC with thermal overload protection on transformer	24V DC with thermal overload protection on transformer	24V DC with thermal overload protection on transformer
Chipset	Smart Entry System auto-calibrating motherboard with LED diagnostics	Smart Entry System auto-calibrating motherboard with LED diagnostics	Smart Entry System auto-calibrating motherboard with Numerical Display diagnostics	Smart Entry System auto-calibrating motherboard with Numerical Display diagnostics
Drive method	Dymetrol belt	Cable & Tooth (Chain or Kevlar Belt Option)	Cable & Tooth (Chain or Kevlar Belt Option)	Cable & Tooth (Chain or Kevlar Belt Option)
Safety door reverse	To fully open position	To fully open position	To fully open position	To fully open position
Light	120W maximum, can be positioned away from the operator (bulb and cabling not included)	Integral 240V fitting with diffuser cover. 40W maximum	Integral 240V fitting with diffuser cover. 40W maximum	Integral 240V fitting with diffuser cover. 40W maximum
Standard boom	1 piece, sits on RHS of door frame	1 piece 'C' channel with 2475mm carriage travel – total operator length 3331mm	1 piece 'C' channel with 2590mm carriage travel – total operator length 3353mm	1 piece 'C' channel with 2590mm carriage travel – total operator length 3353mm
Extended boom (optional) Medium	N/A	N/A	1 piece assembled or 2 piece semi assembled C-channel with 2840mm carriage travel	1 piece assembled or 2 piece semi assembled C-channel with 2840mm carriage travel
Extended boom (optional) Long	N/A	N/A	N/A	1 piece assembled or 2 piece semi assembled C-channel with 3600mm carriage travel
Door size suitability	Up to 2438 x 2134mm (8'0" x 7'0"). Min height 1930mm (6'4")	For Wessex doors up to 4267 x 2134mm (14'0" x 7'0") except 5 Crown doors up to 3048 x 2134mm (10'0" x 7'0")	For Wessex doors up to 4267 x 2286mm (14'0" x 7'6") or 3658 x 2438mm (12'0" x 8'0") except 5 Crown doors up to 3048 x 2134mm (10'0" x 7'0")	For all Wessex retractable and sectional doors including those outside the range of the DC - 550NIII/DC - 650NIII
Headroom required	None	30mm	30mm	30mm
Sideroom required	70mm on RHS of door	None	None	None
Manual disconnect	Yes	Yes	Yes	Yes
Radio receiver	Internal digital, auto-learning rolling code	Digital module. Easy to exchange for other frequencies	Digital module. Easy to exchange for other frequencies	Digital module. Easy to exchange for other frequencies
Radio transmitter	1 x Digital 433 MHz two button mini handset, rolling code (1 billion variations)	2 x digital 868 MHz four button mini handsets, with multibit coding (281 billion variations)	2 digital 868MHz four button mini handsets, with multibit coding (281 billion variations)	2 digital 868MHz four button mini handsets, with multibit coding (281 billion variations)
Transmitter range	10 – 30 metres	10 – 50 metres	10 – 50 metres	10 – 50 metres
Self push button	Yes	No	No	No

# SAFELIFT (CANOPY) DOOR GEAR SPECIFICATIONS

## STANDARD DOOR AND BRICKWORK APERTURE SIZES

• canopy gear should be fitted either to a weatherbeaded 70mm x 70mm (2.3/4" x 2.3/4") standard timber 'goalpost' frame (not supplied) or a Wessex steel frame (standard frame dimensions = 54mm (2.1/8") wide on side section (optional 68mm (2.2/3") available on request) 68mm (2.2/3") high on top section, 35mm (1.1/3") deep all round).

• The minimum headroom required above the lower face of the frame head is 48mm (1.7/8").

### NOTES

• In use the lifting gear reduces drive through heights by 91mm (3.5/8"), although there is no reduction in width.

• For back fixed frames allow the frame to overlap into the aperture by 13mm (1/2") on both sides to allow for coursing and tolerances.

### FITTING FRAMES TO THE BRICKWORK

Frames may be fitted within or behind the brickwork as per the drawings shown. Fitting behind the brickwork, if the garage length allows, will increase the drive-through width.

A weatherbead should always be fitted to the under-side of the door frame lintel in front of the door to hide the top gap. This feature is integral on the Wessex steel frame.

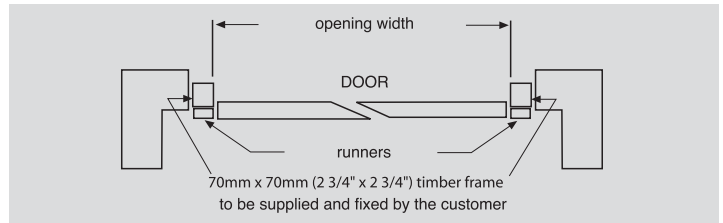

**Fitting to timber frame, within the brickwork aperture.**

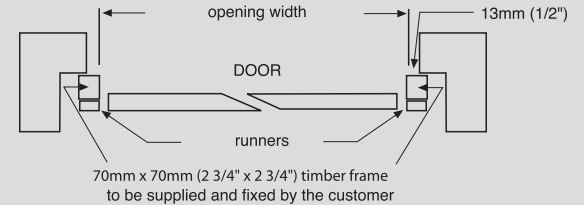

**Fitting to timber frame, behind the brickwork aperture.**

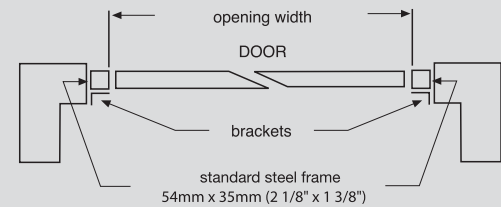

**Fitting to Wessex standard steel canopy frame, within the brickwork aperture.**

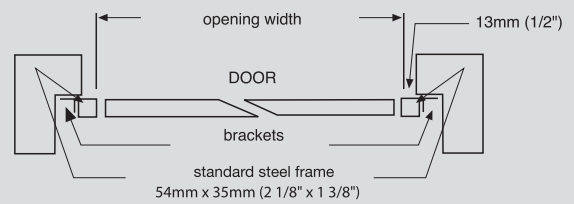

**Fitting to Wessex standard steel canopy frame, behind the brickwork aperture.**

### Opening arcs of travel

Wessex 1981mm (6'6") high SafeLift canopy doors

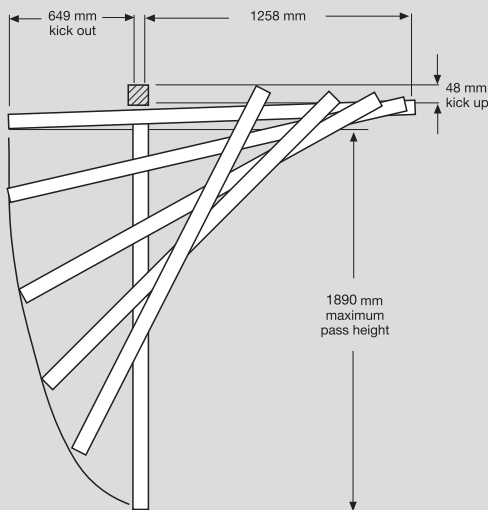

Wessex 2134mm (7'0") high SafeLift canopy doors

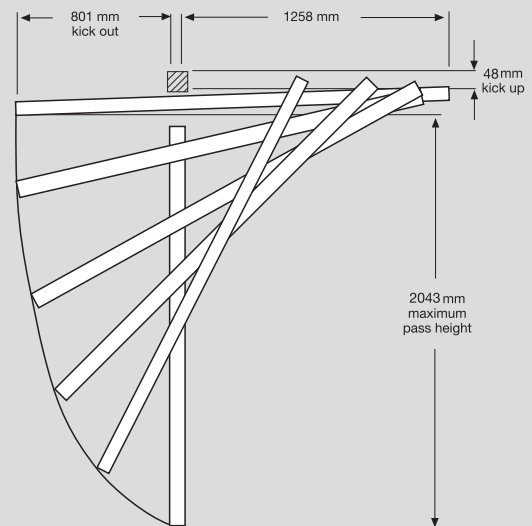

ALL OTHER DOOR SPECIFICATIONS For further information, please ask for details.

# RETRACTABLE DOOR GEAR SPECIFICATIONS

## ALL DOORS

Supplied with Maxi-mizer, Double or Heavy gear depending on size, see page 2.

Wessex retractable door gear should be fitted to a weatherbeaded 70mm x 70mm (2.3/4" x 2.3/4") standard timber 'goalpost' frame (not supplied). Alternatively Maxi-mizer gear may be fitted to a Wessex quick-fit steel retractable frame (dimensions = 68mm (2.2/3") wide by 60mm (2.1/2") deep all round).

Doors supplied with double or heavy gear can also be supplied with an optional steel frame kit not pre-fitted to the door. Dimensions: 68mm (2.2/3") wide x 75mm (3") deep.

## NOTES

In use, lifting gear reduces drive through width by up to 130mm (5.1/4") see below. With Maxi-mizer gear there is no reduction in drive-through width up to 1048mm (3'5.1/4") from the ground on 1981mm (6'6") high doors (1200mm (3'11.1/4") on 2134mm (7'0") high doors.

If drive-through clearances are critical, please ask for full details.

## FITTING FRAMES TO THE BRICKWORK

Frames may be fitted within or behind the brickwork as per the drawings shown. Fitting behind the brickwork, if the garage length allows, will increase drive-through width by up to 114mm (4.1/2").

A 20mm x 20mm (4/5" x 4/5") weatherbead should be fitted to the underside of the door frame lintel in front of the door. This feature is integral on the Wessex steel frame.

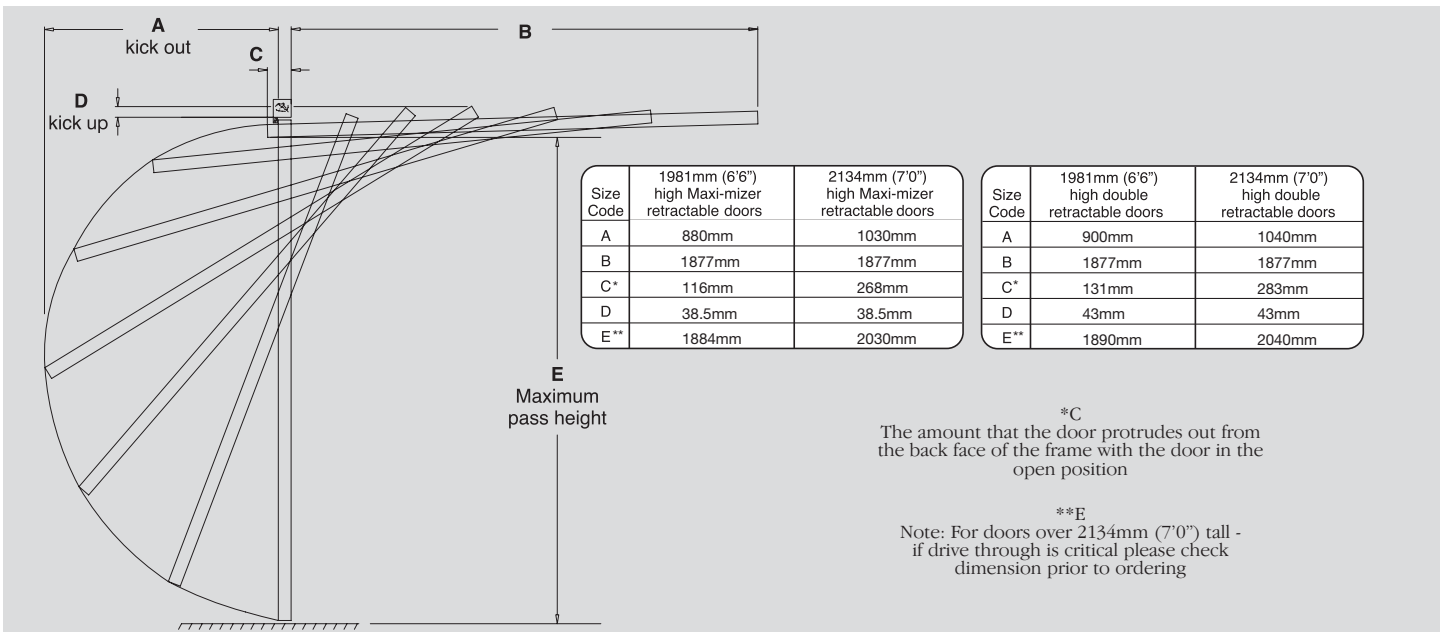
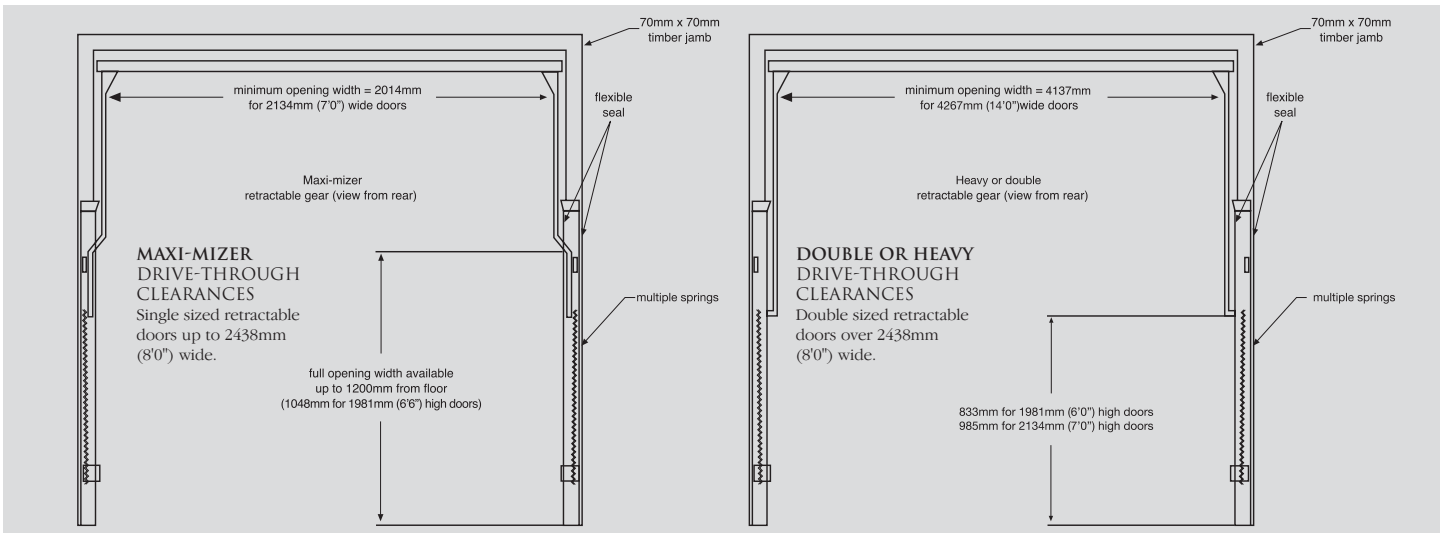
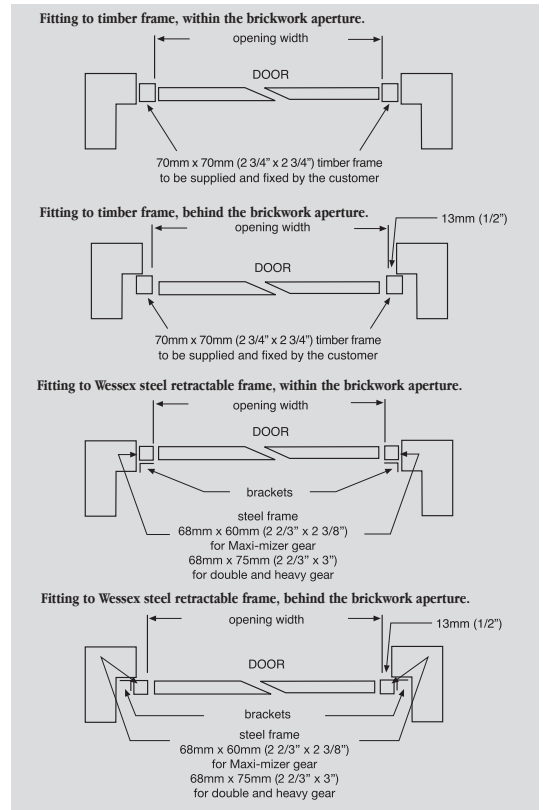



CI/SfB			
127	(31.56)	X	

## PRODUCT WARRANTY – WESSEX GARAGE DOORS LTD. (WESSEX)

### PRODUCT GUARANTEES

Subject to conditions set out below;

- (a) Wessex garage doors are guaranteed against any form of manufacturing defect for a period of 2 years from the date of original purchase.
- (b) Wessex Garage Doors Limited also guarantee that its garage doors will operate safely and reliably for a period of 10 years from original installation.
- (c) Wessex electric operators are guaranteed against any form of manufacturing defect for a period of 5 years for mechanical elements, motors and transformers and for a period of 2 years for other electronic and radio equipment.
- (d) The Exterior finish is guaranteed to provide an effective weatherproof membrane which will resist perforation of the substrate from the weather side due to corrosion for the periods indicated below.  
10 years - GRP  
2 years - Primed Steel, Basecoat Timber Doors
- (e) Colour change or fade to the exterior surface will be limited and uniform for a period of 2 years.

### CONDITIONS

1. During the comprehensive 2 year guarantee period Wessex Garage Doors Limited undertake to repair or replace (at its discretion), and without charge, products or components which have suffered any form of manufacturing defect. Claims must be notified within 3 days from the date of delivery or within a reasonable time after discovery of any defect.
2. Products covered by these guarantees must have been purchased through an authorised Wessex garage door distributor or as original equipment attached to a newly built dwelling.
3. The warranties shall apply for normal use only; Normal use constitutes no more than 5 operations (open/close cycles) per day.
4. The warranties offered attach to the Wessex product only and no consequential damages will apply no matter how caused.
5. No liability will be accepted as a result of normal wear and tear, incorrect storage, incorrect handling, faulty installation, incorrect use or wilful damage.
6. Claims under this guarantee must be made through the original supplier and accompanied by relevant documentation indicating the date of purchase (e.g. receipt).
7. Wessex Garage Doors Limited maximum liability shall be the original purchase price inclusive of Value Added Tax at the rate prevailing when supplied.
8. Any product which is the subject of a claim:
  - i) must have been correctly installed in accordance with the installation instructions supplied and thereafter properly maintained by a suitably experienced engineer on a regular basis as set out in the Maintenance and Operating Instructions provided with every door. (Additional copies of these instructions are available by calling 01202 825451). We recommend that regular maintenance is provided by a suitably experienced engineer. See your Yellow Pages for your local Wessex Garage Door or AGDS specialist.
  - ii) must have the manufacturers reference number still intact (found on the barcode label on the door)
  - iii) must not have been modified in any way.
9. Claims will not be accepted where the cause is due to:
  - i) impact or mechanical damage suffered during or following installation, e.g scratches, indentations, tears, scuffs or other surface abrasion.
  - ii) damage or discolouration caused by contact with any form of caustic, abrasive or corrosive substance, fumes, bird droppings, fire, smoke, floodwater, salts, acids, or from exposure to abnormal atmospheric pollution.
10. This guarantee excludes normal wear and tear on items such as cones, cables, spindles, lock cylinders, hinges or springs.
11. Only Wessex original spare parts must be used when required. The use of non-Wessex parts shall invalidate this guarantee. Warranty period for replacement parts is 6 months or the balance of the original warranty period if greater.

12. The Exterior Finish Guarantee applies only to the weatherside surface and where more than 5% of the surface area of the door is affected. Surfaces must be freely exposed to washing by rainfall and kept clear of accumulated dirt and debris and given equal exposure to local environmental conditions and consistent natural lighting conditions across the face of the door. Special attention is drawn to Clause (9) (i).
13. Primed steel doors and basecoat treated timber doors must receive a suitable exterior quality finishing topcoat immediately after installation. This topcoat finish must be applied strictly in accordance with the manufacturer's instructions.
14. The guarantee period for electric operators excludes batteries, fuses and light bulbs.
15. Parts replaced free of charge become the property of Wessex Garage Doors Limited.
16. Attempted repairs by non-qualified individuals shall invalidate this guarantee.
17. The specific terms of this guarantee shall only apply to products purchased on or after April 2008 within the UK and Eire.
18. Wessex garage doors and associated products are sold subject to the Wessex Garage Doors Limited Standard Terms and Conditions of Sale, copies of which are available upon request. Wessex Garage Doors Limited shall not be liable as a result of any representation, implied warranty or other term or condition or for any consequential loss or damage, costs, expenses or other claims whatsoever except as expressly set out in these Terms and Conditions of Sale.

### General Advice

#### Door Cleaning

Periodically clean the door panel using warm water and a soft cloth or sponge. Allow to dry naturally. Never use detergent, abrasive, caustic or solvent based cleaners as they may damage the door surface. Bird droppings should be removed immediately as these can be particularly caustic.

#### Customer Maintenance

Moving parts should be lubricated regularly to ensure smooth operation. Every six months visually inspect all wear items (including cables) for signs of wear. If wear is detected we recommend you contact your local Wessex approved service engineer to arrange for a replacement. Garage door springs are under extreme tension and should only be repaired or replaced by a suitably qualified engineer.

Other performance issues affecting Wessex. garage doors are:

Wessex G.R.P doors are individually handcrafted products manufactured to specific customer order. Due to the nature of the product and the hand finishing processes used they may occasionally display small blemishes which do not detract from the overall appearance of the product. These are regarded as being within manufacturers tolerance when such blemishes are not visible to the naked eye when viewed from a distance of three metres. Similarly, Woodgrain effect products will, like the natural material, display colour variations across their surface and colour will vary from door to door. Ordering doors to match helps reduce the variation but will not eradicate it entirely.

**Translucency of the door panel may vary when viewed from the inside on a bright day due to variations in laminate thickness. This does not represent a manufacturing defect and overall performance is not affected.**

**Size and Deflection** - the natural curing process does not affect the ultimate product size and a tolerance of  $\pm 6\text{mm}$  on both height and width is deemed acceptable. Up and over doors in the 'open' position will display a level of vertical deflection or 'sag' across the width of the panel and up to 6mm per linear metre is within design tolerance.

Wessex Timber doors are made from the finest timber obtained from managed and sustainable sources. Prior to fitting they must not be stored in direct sunlight or exposed to splashes or rain as colour fading and/or staining may result. The Wessex product guarantee does not cover natural variations in colour, warping, swelling or shrinkage due to the ordinary natural processes of ageing, fading or the effects of weather or climate nor does it cover the incidence of similar degradation which could have been prevented by carrying out finishing and maintenance procedures as recommended by Wessex.

Wessex Steel doors are manufactured using high quality galvanised steel with a white powder coated primed finish as standard (except oversize doors). A suitable exterior grade of paint should be applied as a finishing coat in accordance with the paint manufacturers instructions.

**These terms and conditions do not affect your statutory rights.**